

INTERCOOLER KIT INSTALLTION MANUAL

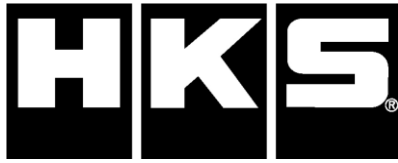

Installation must be done by a professional.
Read this manual prior to the installation.

Always have access to this manual as well as a factory service manual.

※ Make sure the vehicle is applicable to this kit.

NAME OF PRODUCT	INTERCOOLER KIT
PART NUMBER	13001-AZ004
APPLICATION	MAZDA RX-7 FD3S
ENGINE	13B-REW
YEAR	1991/12-2002/08 (A/C Pipe: 1993/07-2002/08)
REMARKS	<p>【NOTICE】</p> <ul style="list-style-type: none">• Modification of the vehicle body and factory parts is required.• Change of the battery size is required. Installation position must be changed if an undesignated battery is used. <p>In order to install this product to a vehicle having cold districts specification, it is recommended to change the battery's installation position since the battery capacity is larger than a standard model.</p> <ul style="list-style-type: none">• Use a factory radiator or factory replacement type radiator. If the thickness of a core exceeds 70mm, modification of an electric fan bracket is required. <p>【Required Parts】</p> <ul style="list-style-type: none">• Cord (Cross-section: 0.85mm² or larger, Length: 8m) to extend a wire.• Battery (Battery Size: 38B19R (New JIS Standard), Size: 187x129x210 or smaller) ※Battery's top surface must be flat.• HKS Racing Suction Reloaded (P/N 70020-AZ001)• Coolant water



















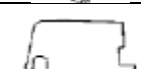
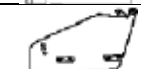

NOTICE

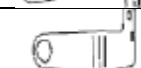
This manual assumes that you have and know how to use the tools and equipment necessary to safely perform service operations on your vehicle. This manual assumes that you are familiar with typical automotive systems and basic service and repair procedures. Do not attempt to carry out the operations shown in this manual unless these assumptions are correct. Always have access to a factory service manual. To avoid injury, follow the safety precautions contained in the factory service manual.



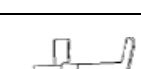

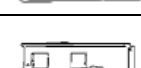
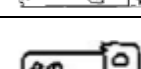
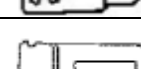
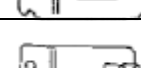

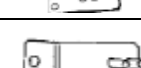

















REVISION OF MANUAL

Rev. Number	Date	Details
3-3.01	2003/08	1 st Edition
3-3.02	2003/09	Parts list revised.
3-3.03	2008/08	Parts list revised. Format changed.













PARTS LIST

No.	PART NUMBER	DESCRIPTION	QT	IMAGE	REMARKS
1	G17910-Z60010-00	INTERCOOLER CORE Assy	1		
2	G16451-Z60010-00	RADIATOR INLET PIPE	1		
3	G16461-Z60010-00	RADIATOR OUTLET PIPE	1		
4	G17951-Z60020-00	INTERCOOLER INLET PIPE	1		
5	G17971-Z60010-00	INTERCOOLER OUTLET PIPE No.2	1		
6	G17971-Z60020-00	INTERCOOLER OUTLET PIPE No.1	1		
7	G88460-Z60011-00	A/C PIPE No.1	1		
8	G88420-Z60010-00	A/C PIPE No.2	1		
9	G17931-Z60010-00	AIR GUIDE	1		
10	G17921-Z60041-00	INTERCOOLER BRACKET No.1	1		Driver's side
11	G17921-Z60050-00	INTERCOOLER BRACKET No.2	1		Passenger's side
12	G17921-Z60060-00	INTERCOOLER BRACKET No.3	1		
13	G16441-Z60010-00	RADIATOR BRACKET No.1	1		
14	G16441-Z600020-00	RADIATOR BRACKET No.2	1		
15	G82275-Z60010-00	HARNESS BRACKET No.1	1		
16	16262-001327AO	HARNESS BRACKET No.2	1		
17	17311-520327	AIR SEPARATOR TANK BRACKET	1		
18	G16483-Z60010-00	RECIEVER TANK BRACKET	1		
19	G28853-Z60010-00	BATTERY BRACKET	1		
20	G28851-Z60010-00	BATTERY TRAY	1		
21	G16333-Z60010-00	ELECTRIC FAN BRACKET No.1	2		
22	G16333-Z60010-00	ELECTRIC FAN BRACKET No.2	2		
23	G16333-Z60020-00	ELECTRIC FAN BRACKET No.3	1		
24	G16333-Z60030-00	ELECTRIC FAN BRACKET No.4	1		
25	G16333-Z60040-00	ELECTRIC FAN BRACKET No.5	1		

PARTS LIST

No.	PART NUMBER	DESCRIPTION	QT	IMAGE	REMARKS
26	G16333-Z60010-00	ELECTRIC FAN BRACKET No.6	1		
27	G16333-Z60020-00	ELECTRIC FAN BRACKET No.7	1		
28	G16333-Z60030-00	ELECTRIC FAN BRACKET No.8	1		
29	G16333-Z60040-00	COLLAR L=10	1		
30	G16333-Z60050-00	COLLAR L=15	1		
31	G16333-Z60060-00	COLLAR L=35	1		
32	G16333-Z60070-00	COLLAR L=60	1		
33	G16333-Z60080-00	BATTERY COLLAR	2		
34	G09971-Z60030-00	O-RING (L)	1		
35	G09971-Z60020-00	O-RING (S)	2		
36	G09971-Z60010-00	SILICONE HOSE 70mm W/ CUSHION	2		
37	G28891-Z60010-00	SILICON HOSE 70mm	2		
38	91161-107327	HOSE CLAMP #28	8		
39	91731-107327	HOSE CLAMP #48	9		
40	91731-106327	OIL-RESISTANT HOSE 12mm	1		L=1000
41	1803-SA045	JOINT PIPE 12mm	1		
42	1803-SA030	BOLT M6 L=15	21		P=1.0
43	18005-AK006	BOLT M6 L=20	1		P=1.0
44	18005-AK011	BOLT M6 L=25	1		P=1.0
45	1801-SA007	BOLT M6 L=55	1		P=1.0
46	18006-AK013	BOLT M6 L=80	1		P=1.0 SUS
47		BOLT M8 L=15	3		P=1.25
48		BOLT M10 L=20	2		P=1.25
49		NUT M5	6		
50		NUT M6	12		

PARTS LIST

No.	PART NUMBER	DESCRIPTION	QT	IMAGE	REMARKS
51		FLANGE NUT M6	14		
52		FLAT WASHER M6	27		
53		FLAT WASHER M6 MAJOR DIA.	10		
54		FLAT WASHER M8	3		
55		SPRING WASHER M6	37		
56		SPRING WASHER M8	3		
57		SPRING WASHER M10	2		
58		FLAT WASHER M5	6		
59		FLAT WASHER M10	2		
60		TIE WRAP (L)	10		
61		TIE WRAP (S)	10		
62		INSTRUCTION MANUAL	1		
63		INSTALLATION MANUAL	1		

1. Removal of Factory Parts

Before installation, prepare coolant water and disconnect the negative cable from the battery.

Use this instruction manual and the manufacture's service manual as a reference.

※1.(14) is required only for the vehicle manufactured after December, 1998.

(1) Remove the factory parts referring to the manual included in HKS Racing Suction Reloaded (P/N 70020-AZ001).

(2) Vent gas from the air conditioner.

NOTE

- If there is no gas recovering apparatus, ask a professional for gas recovery before installation.

(3) Remove the front under cover and drain the coolant.

(4) Remove the front bumper face and air guide. (Dia.1-1)

(5) Remove the battery and battery tray.

NOTE

- Disconnect the positive cable from the battery after disconnecting the negative cable.

(6) Remove the fresh air duct, disconnect the hose from the intercooler core assy and air separator tank, and remove the intercooler core assy, air duct, and air separator tank. (Dia.1-2)

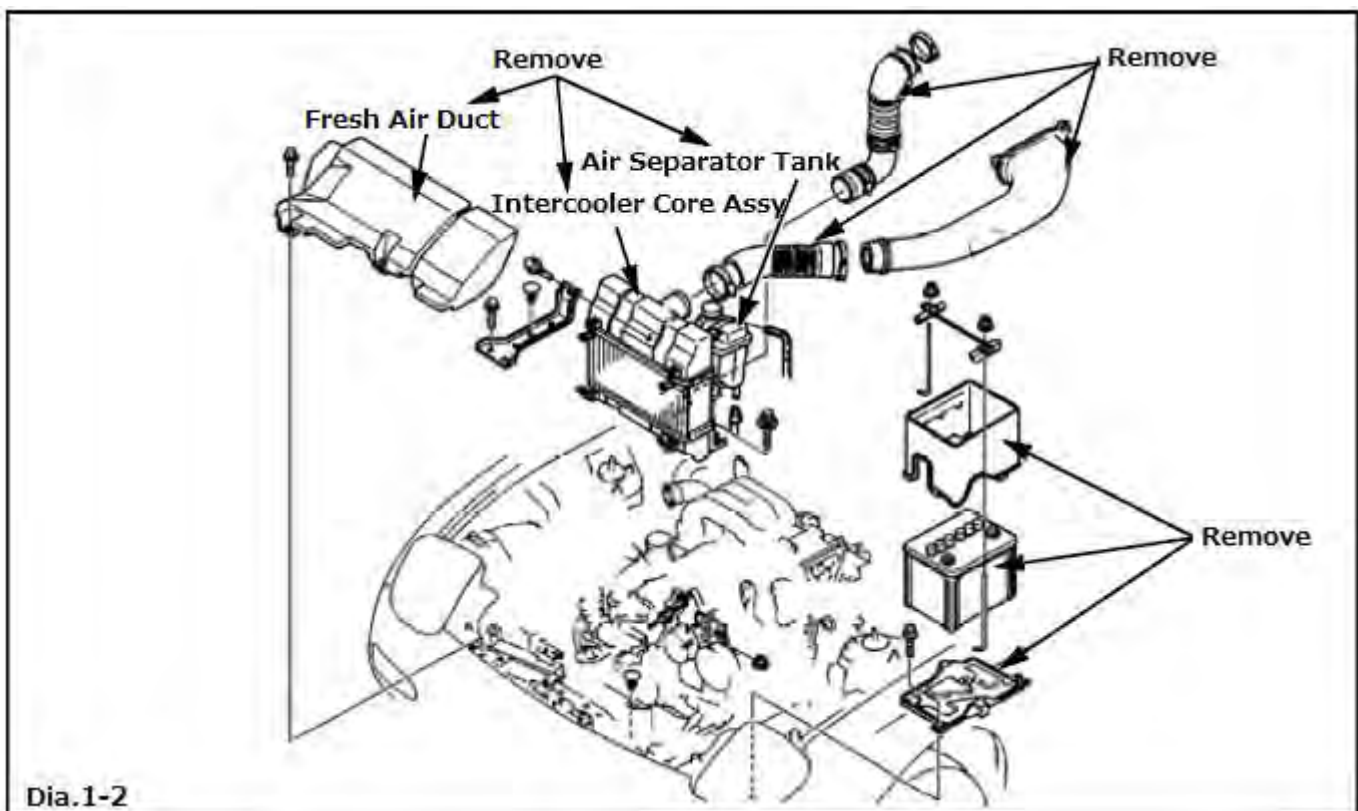
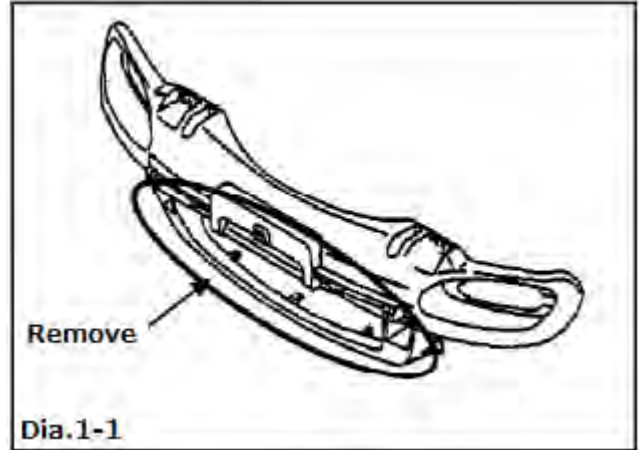

- (7) Remove the power steering pipe and return hose from the position indicated by arrows in the diagram 1-3.

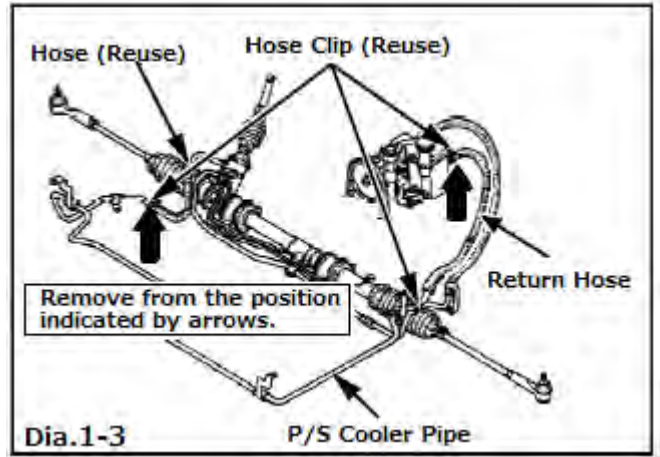

- (8) Remove the fuse box, relay box, and bracket. (Dia.1-4)

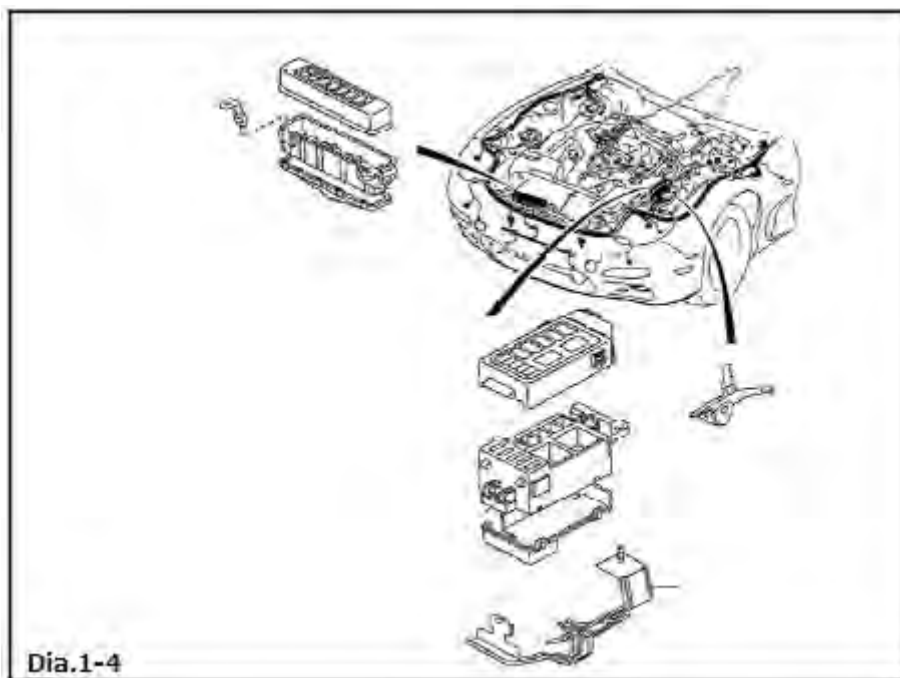

- (9) Remove the radiator hose (both upper and lower).

- (10) Remove the radiator.

- (11) Remove the rubber mount from the upper radiator installation position on the vehicle's side.

NOTE

- The rubber mounts are installed on both sides. Make sure to remove it from both sides.

- (12) Remove the A/C pipe from the position indicated by an arrow in the diagram. (Dia.1-5)

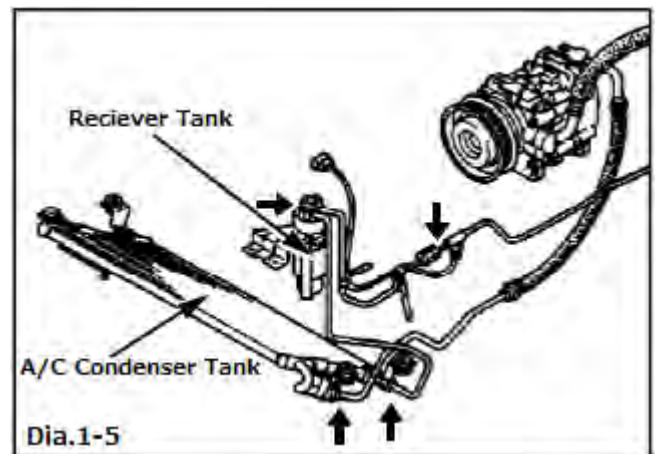

- (13) Remove the A/C condenser and receiver tank. (Dia.1-5)

For a Vehicle Manufactured after December, 1998

- (14) Remove the horns and horn brackets from both sides.

2. Modification of Factory Parts

2-1. Modification of Electric Fan Wiring

- (1) Extend the wire of the factory electric fan by 800mm.
- (2) Bundle the wires using the provided Tie Wrap (S).

2-2. Modification of Fuse box Wiring

- (1) Extend four wires of the fuse box (blue/black, black/white, white/green, and red) by 400mm. (Dia.2-2-1)
- (2) Bundle the wires using the provided Tie Wrap (L).

CAUTION

- When extending the wires, make sure to handle them properly. If neglected, it may cause a short circuit and/or malfunction of the electric fan. A short circuit may cause fire.



3. Installation of Kit Parts

Install HKS Racing Suction Reloaded (P/N 70020-AZ001) referring to the manual included in the kit.

3-1. Installation of Power Steering Hose

- (1) Connect the pipes for the power steering using the following provided parts. (Dia.3-1-1)
 - Oil Resistant Hose 12mm x 1 (P40)
 - Joint Pipe 12mm x 1 (P41)
 - Factory Hose
 - Factory Hose Clips
- (2) Secure the Oil Resistant Hose 12mm to the vehicle using the provided Tie Wrap (L).

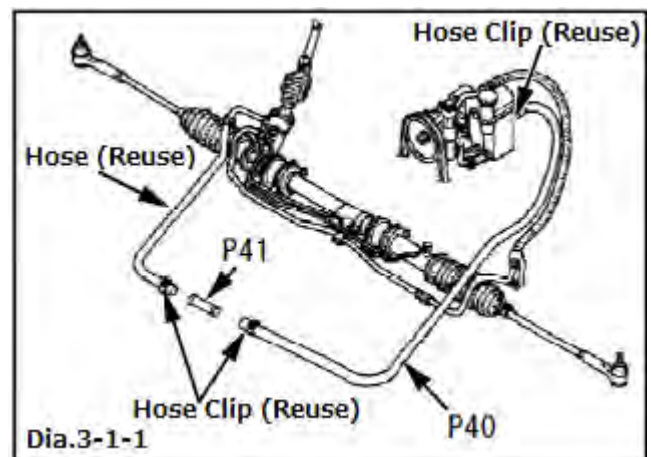

3-2. Installation of Brackets

(1) Install the following provided radiator bracket No.1 and No.2 to the member. (Dia.3-2-1)

- Radiator Bracket No.1 x 1 (P13)
- Radiator Bracket No.2 x 1 (P14)
- Factory Bolt x 4

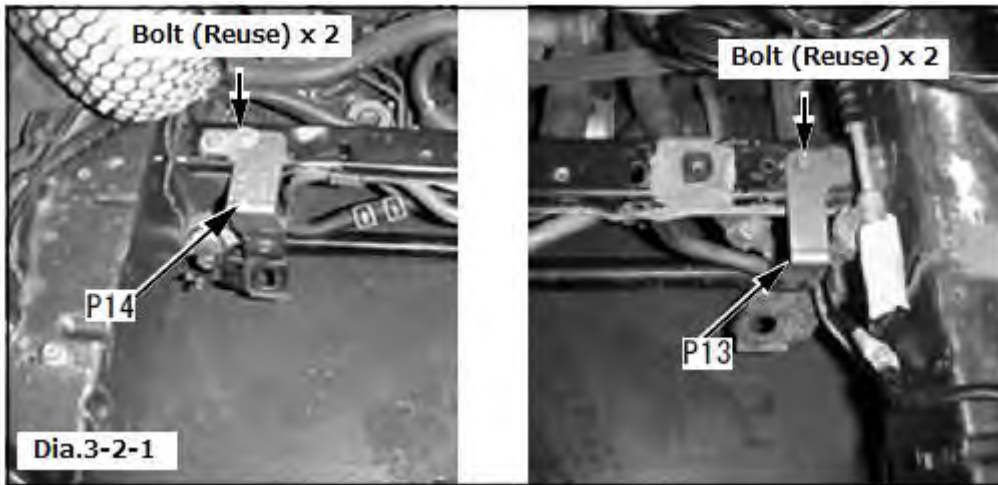

(2) Install the provided Intercooler Bracket No.1 and No.2 using the following provided parts. (Dia.3-2-2, 3-2-3)

- Intercooler Bracket No.1 x 1 (P10)
- Intercooler Bracket No.2 x 1 (P11)
- Bolt M6 L=15 x 4 (P42)
- Bolt M10 L=20 x 2 (P48)
- Flat Washer M6 x 4 (P52)
- Spring Washer M6 x 4 (P55)
- Spring Washer M10 x 2 (P57)
- Flat Washer M10 x 2 (P59)

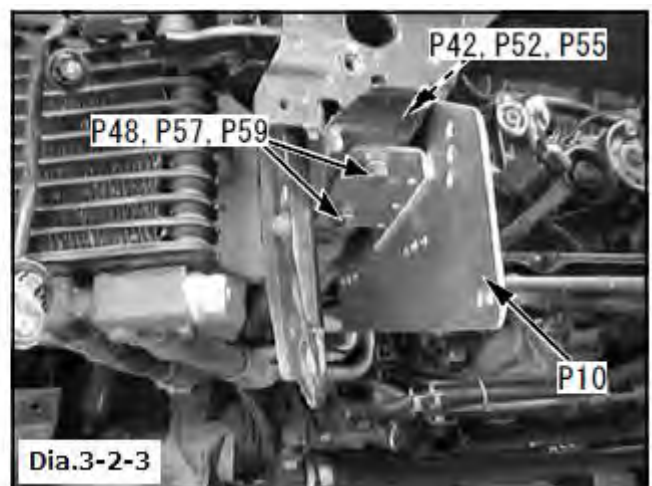
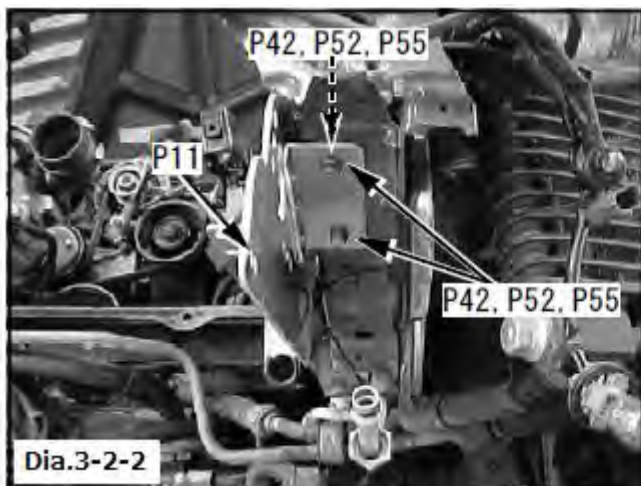

3-3. Installation of Radiator

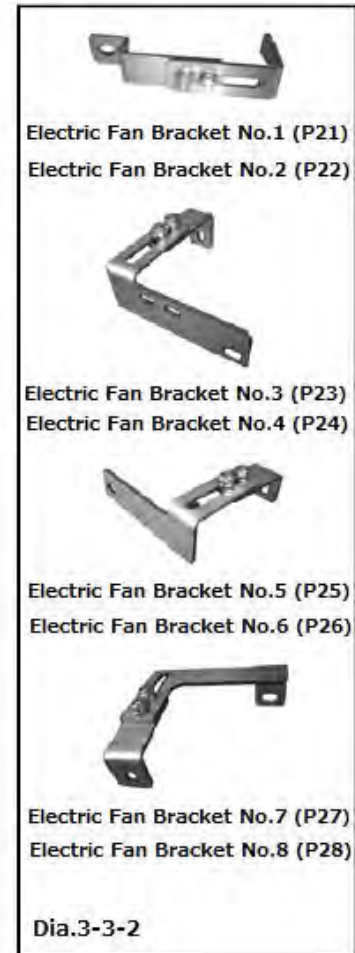
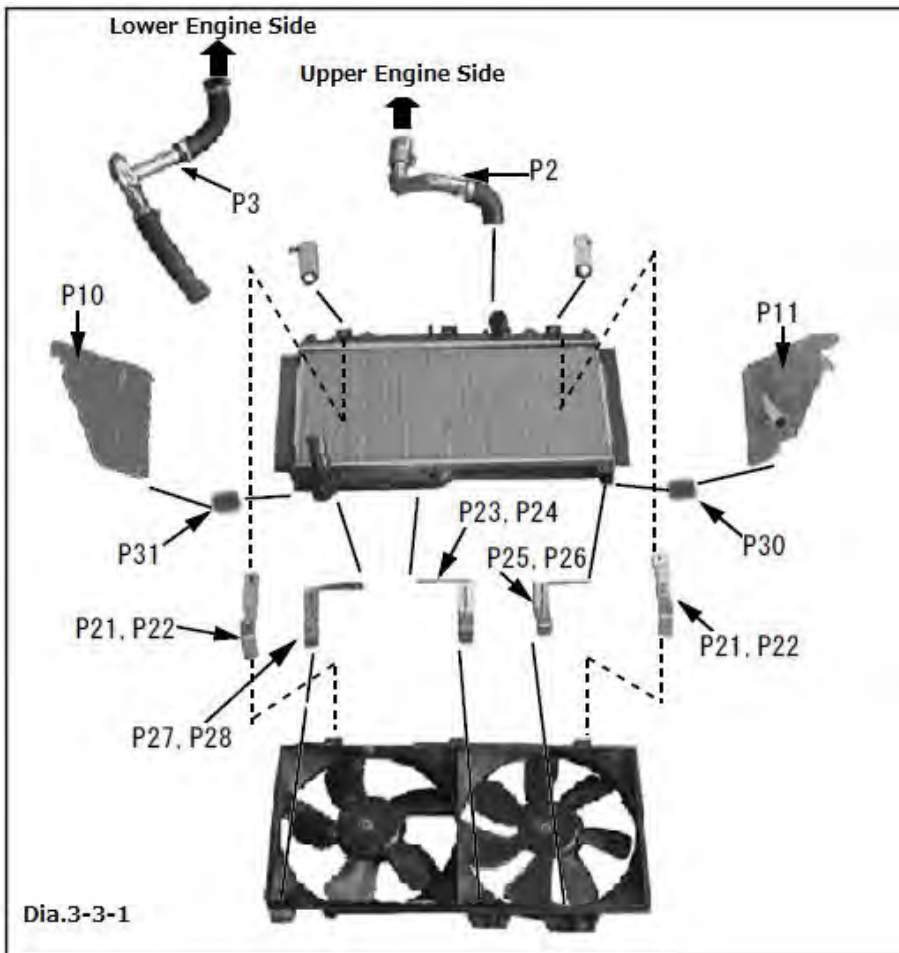

(1) Assemble the provided Electric Fan No.1 with No.2, No.3 with No.4, No.5 with No.6, and No.7 with No.8 as shown in the diagram 3-3-2.

- Electric Fan No.1 x 2 (P21)
- Electric Fan No.2 x 2 (P22)
- Electric Fan No.3 x 1 (P23)
- Electric Fan No.4 x 1 (P24)
- Electric Fan No.5 x 1 (P25)
- Electric Fan No.6 x 1 (P26)
- Electric Fan No.7 x 1 (P27)
- Electric Fan No.8 x 1 (P28)
- Nut M6 x 10 (P50)
- Flat Washer M6 x 10 (P52)
- Spring Washer M6 x 10 (P55)

NOTE

- The number carved on the bracket corresponds with the part number of each bracket. The number on the bracket shows only 6-digit from the part number.

(2) Install the radiator and electric fan inserting them between the Electric Fan Bracket No.3 to No.8 and using the following provided parts. Adjust the length of the bracket according to the thickness of the radiator.

- Bolt M6 L=15 x 6 (P42)
- Flange Nut M6 x 4 (P51)
- Flat Washer M6 Major Dia. x 6 (P53)
- Spring Washer M6 x 6 (P55)

NOTE

- The air guide and Electric Fan Bracket No.1 and No.2 are tightened together. Adjust the length of the bracket only

(3) Install the radiator using the following parts. (Dia.3-3-1)

- Collar L=15 x 1 (P30)
- Collar L=35 x 1 (P31)
- Bolt M6 L=25 x 1 (P44)
- Bolt M6 L=55 x 1 (P45)
- Flat Washer M6 Major Dia. x2 (P53)
- Spring Washer M6 x 2 (P55)

(4) Connect a hose to the air separator tank.

NOTE

- There are extra Nut M6 included. Use those extra nuts to install the large capacity radiator.

3-4. Installation of Air Conditioner Condenser

(1) Install the air conditioner condenser to the Intercooler Bracket No. 1 and No.2 using the following provided parts. (Dia.3-4-1)

- Nut M5 x 6 (P49)
- Flat Washer M5 x 6 (P58)
- Factory Bolt M5 x 6

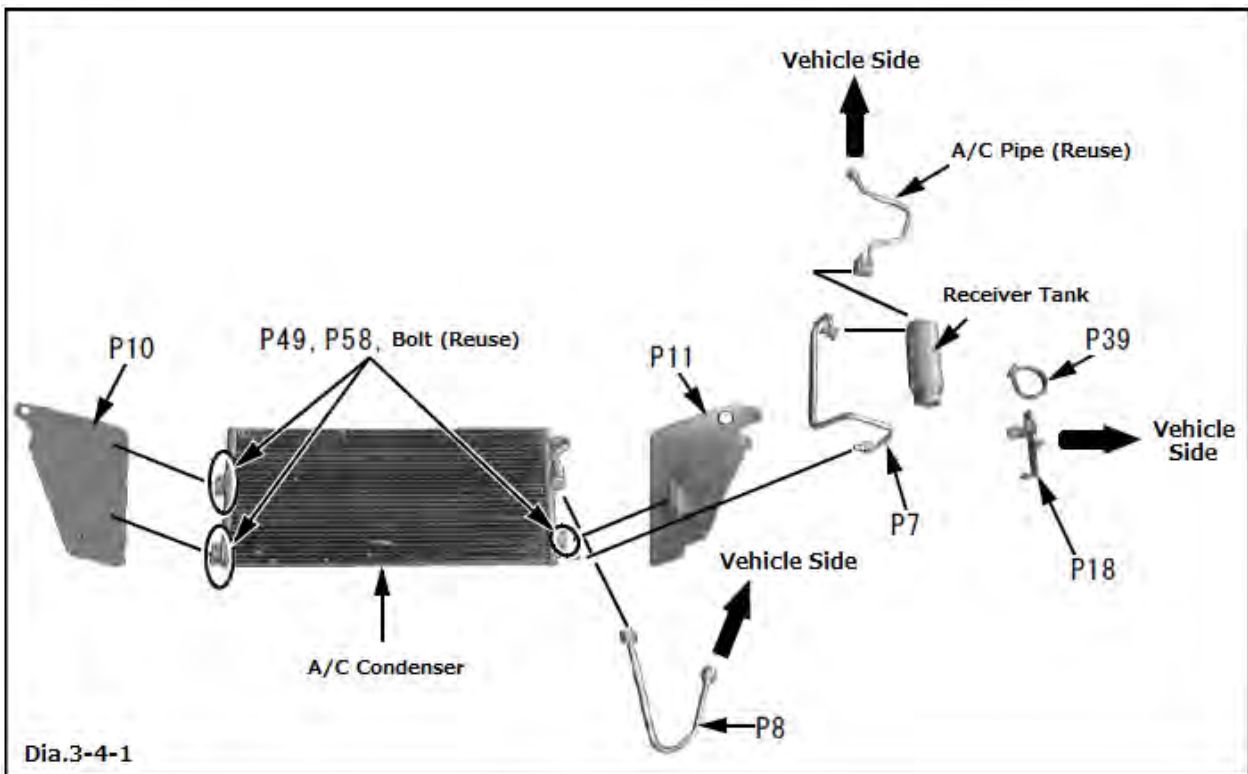

3-5. Installation of Air Guide

(1) Install the factory rubber mount to the Air Guide using the following provided parts. (Dia.3-5-1)

- Air Guide x 1 (P9)
- Flange Nut M6 x 2 (P51)

(2) Tighten the radiator and Electric Fan Bracket No.1 and No.2 together with the rubber mount using the following provided part. (Dia.3-5-2)

- Flange Nut M6 x 2 (P51)

NOTE

- Secure the parts on the intercooler side after installing the A/C pipe.

(3) Secure the electric fan and Electric Fan Bracket No.1 and No.2 using the following provided part.

- Tie Wrap (S) (P61)

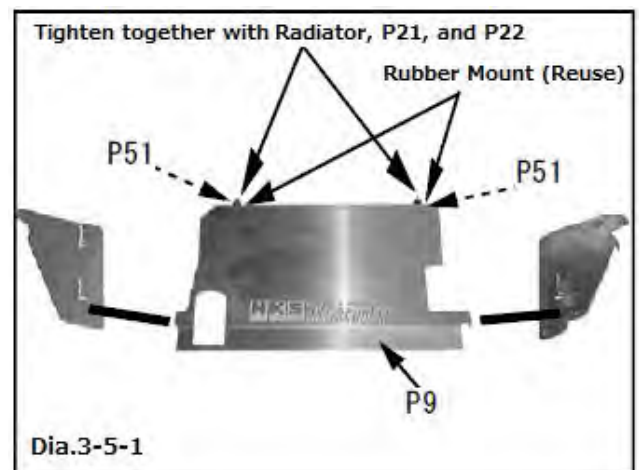

3-6. Installation of A/C Pipe No.1 and No.2

NOTE

- Before installing the A/C Pipe No.1 and No.2, blow air into these pipes to remove any foreign objects from the inside of pipes.

- (1) Bent the factory A/C pipe (Receiver tank ⇔ Vehicle) so it can fit with the installation position on the vehicle side as shown in the diagram 3-6-1.

NOTE

- Handle the pipe with care to prevent the breakage of the pipe.

- (2) Install the receiver tank using the following provided parts. (Dia.3-6-2)

- Receiver Tank Bracket x 1 (P18)
- Hose Clamp #48 x 1 (P39)
- Bolt M6 L=15 x 1 (P42)
- Flat Washer M6 x 1 (P52)
- Spring Washer M6 x 1 (P55)

- (3) Install the O-ring (S) to the A/C Pipe No.1 using the following provided parts.

- A/C Pipe No.1 x 1 (P7)
- O-ring (S) x 2 (P35)

- (4) Install the A/C Pipe No.1 to the vehicle. (Dia.3-6-3, 3-4-1)

- (5) Install the O-ring (L) to the A/C Pipe No.2 using the following provided parts.

- A/C Pipe No.2 x 1 (P8)
- O-ring (L) x 1 (P34)

- (6) Install the A/C Pipe No.2 to the vehicle. (Dia.3-6-3, 3-4-1)

NOTE

- Bent the pipe so the A/C Pipe No.1 does not come in contact with A/C Pipe No.2.

- (7) Secure the A/C Pipe No.1 and No.2 using the provide Tie Wrap (L).

- Tie Wrap (L) (P60)

- (8) Install the factory air conditioner pipe to the receiver tank and vehicle.

- (9) Install the air guide using the following provided parts. (Dia.3-5-1)

- Bolt M6 L=15 x 2 (P42)
- Flange Nut M6 x 2 (P51)
- Flat Washer M6 Major Dia. x 2 (P53)
- Spring Washer M6 x 2 (P55)

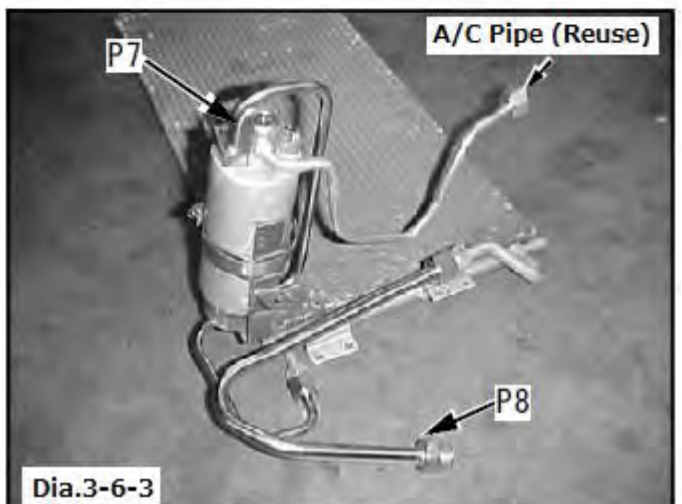
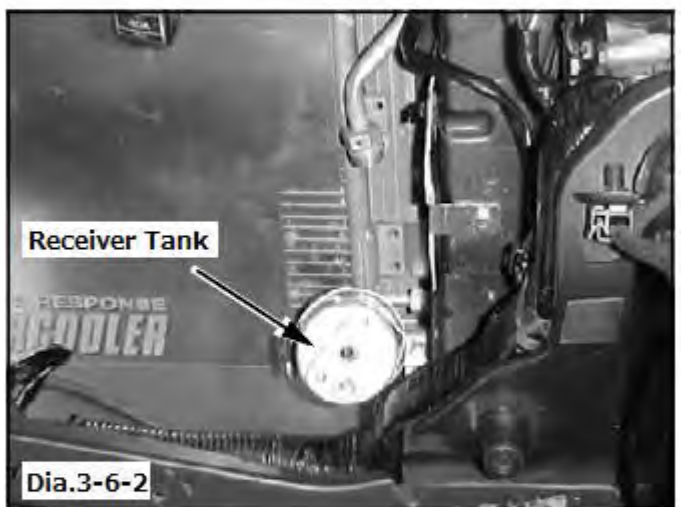
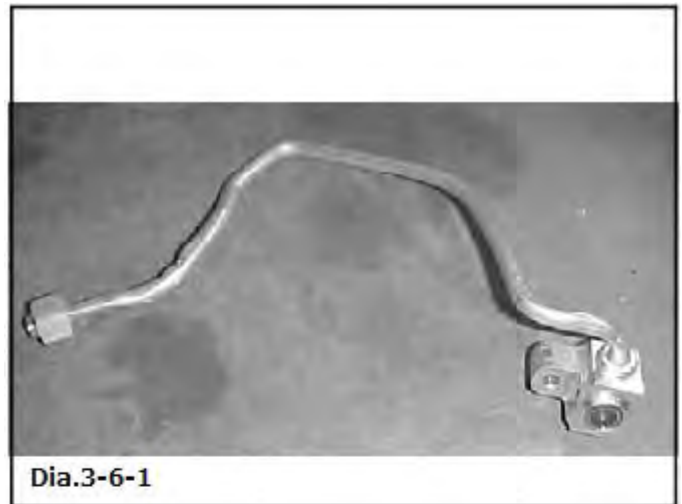

3-7. Installation of Radiator Hose

(1) Cut the radiator hose (upper and lower) at the dotted lines shown in the diagram 3-7-1.

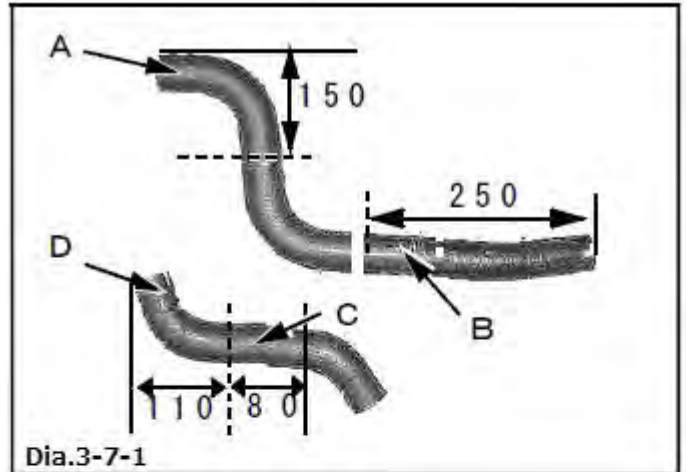

(2) Install the radiator hose "C" and "D" made in 3-7(1) to the Radiator Inlet Pipe using the provided Hose Clamp #28. (Dia.3-7-1, 3-7-2)

- Radiator Inlet Pipe x 1 (P2)
- Hose Clamp #28 x 4 (P38)

(3) Install the radiator hose "A" and "B" made in 3-7(1) to the Radiator Outlet Pipe using the provided Hose Clamp #28. (Dia.3-7-2)

- Radiator Outlet Pipe x 1 (P3)
- Hose Clamp #28 x 4 (P38)

NOTE

- Secure the radiator pipe using the provided Tie Wrap (L) if the pipe comes in contact with the vehicle.

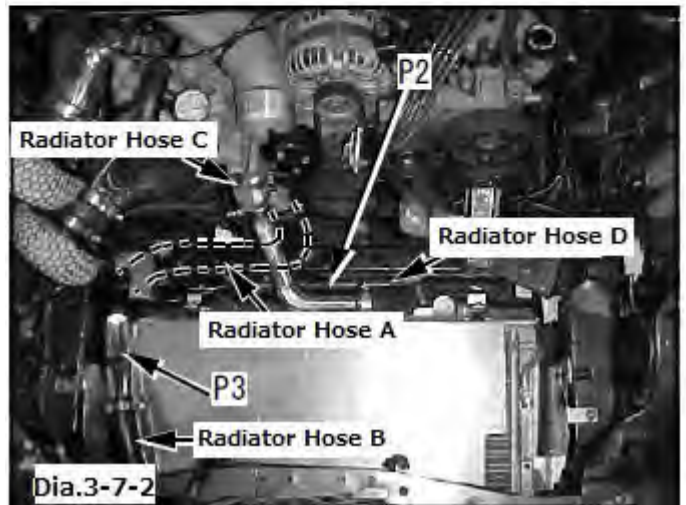

3-8. Installation of Intercooler Core Assy

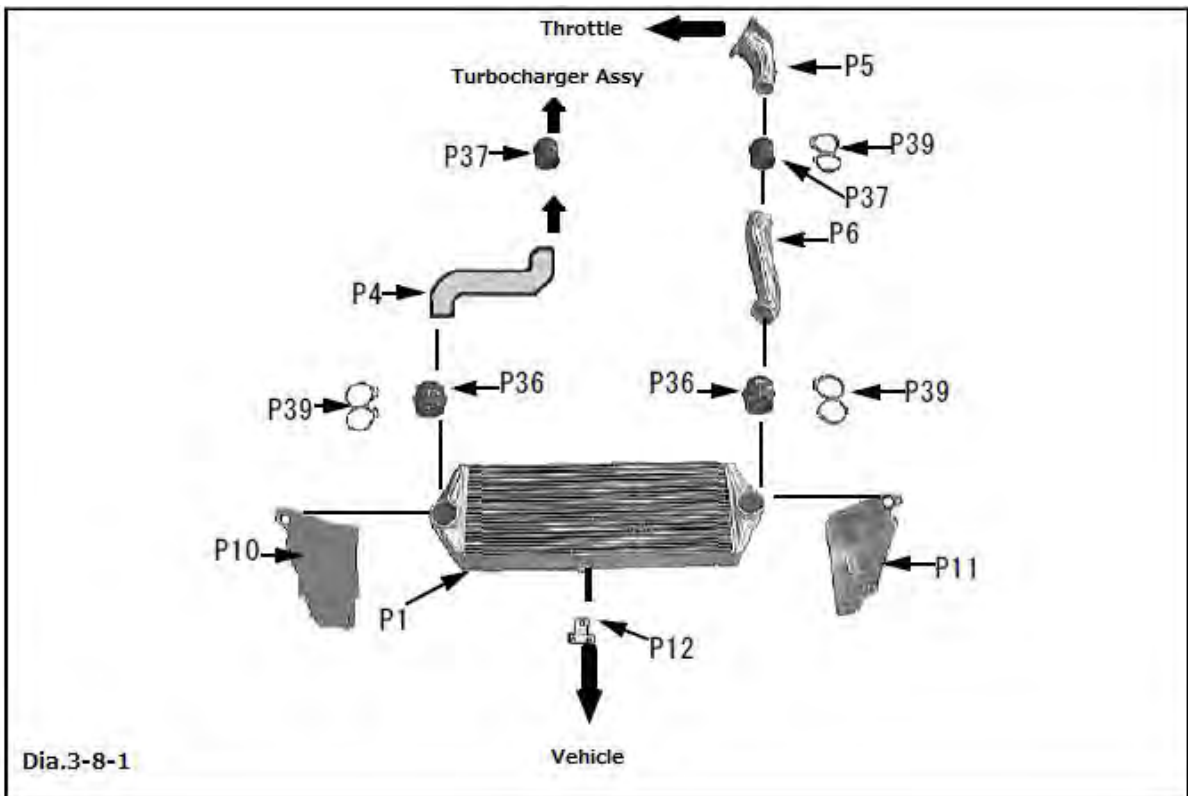

(1) Install the Intercooler Core Assy to the vehicle using the following provided parts. (Dia.3-8-1, 3-8-2)

- Intercooler Core Assy x 1 (P1)
- Intercooler Core Bracket x 1 (P12)
- Bolt M6 L=15 x 2 (P42)
- Bolt M8 L=15 x 3 (P47)
- Flat Washer M6 x 2 (P52)
- Flat Washer M8 x 3 (P54)
- Spring Washer M6 x 2 (P55)
- Spring Washer M8 x 3 (P56)

NOTE

- Adjust the position of the radiator pipe so the pipe does not come in contact with the intercooler core assy.

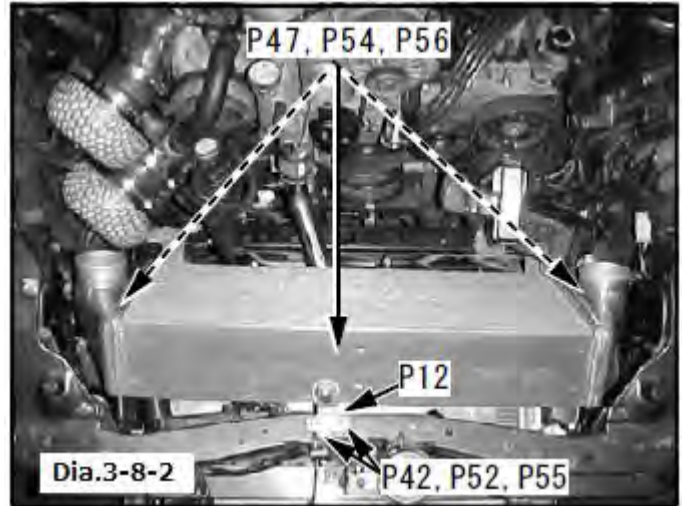

(2) Install the Intercooler Outlet Pipe No.2 using the following provided parts.

- Intercooler Outlet Pipe No.2 x 1 (P5)
- Factory Nut

(3) Install the Intercooler Inlet Pipe and Intercooler Outlet Pipe No.1 using the following provided parts.

- Intercooler Inlet Pipe x 1 (P4)
- Intercooler Outlet Pipe x 1 (P6)
- Silicone Hose 70mm w/ Cushion x 2 (P36)
- Silicone Hose 70mm x 2 (P37)
- Hose Clamp #48 x 8 (P39)

3-9. Installation of Battery

(1) Install the Harness Bracket No.1 and No.2 to the vehicle using the following provided parts. (Dia.3-9-1)

- Harness Bracket x 1 (P15)
- Harness Bracket x 1 (P16)
- Bolt M6 L=15 x 3 (P42)
- Flat Washer M6 x 3 (P52)
- Spring Washer M6 x 3 (P55)

(2) Secure the relay, diagnosis connector, and coupler to the Harness Bracket No.1. (Dia.3-9-1)

(3) Secure the harness to the Harness Bracket No.2 using the provided Tie Wrap (S). (Dia.3-9-1)

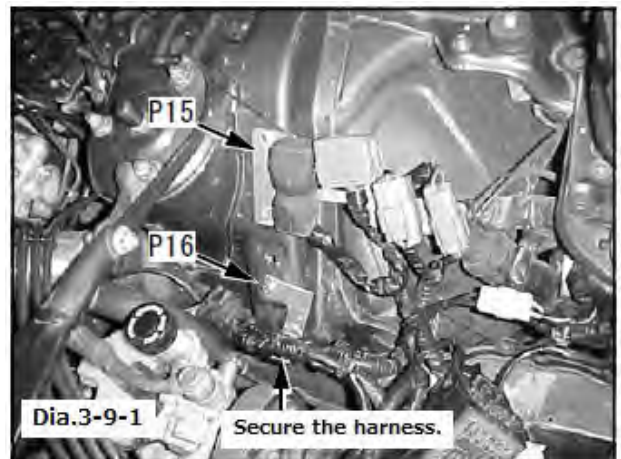

(4) Install the Battery Tray to the vehicle using the following provided parts. (Dia.3-9-2)

- Battery Tray x 1 (P20)
- Collar L=10 x 1 (P29)
- Collar L=60 x 1 (P32)
- Bolt M6 L=15 x 1 (P42)
- Bolt M6 L=20 x 1 (P43)
- Bolt M6 L=80 x 1 (P46)
- Flat Washer M6 x 3 (P52)
- Spring Washer M6 x 3 (P55)

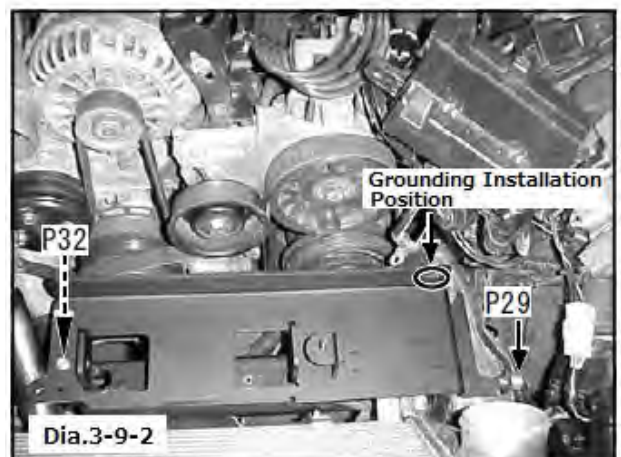

(5) Install the fuse box using the following provided part.
(Dia.3-9-3)

- Flange Nut M6 x 1 (P51)

(6) Install the grounding part of the harness's negative side using the following provided parts.
(Dia.3-9-2)

- Bolt M6 L=15 x 1 (P42)
- Flange Nut M6 x 1 (P51)
- Flat Washer M6 x 1 (P52)
- Spring Washer M6 x 1 (P55)

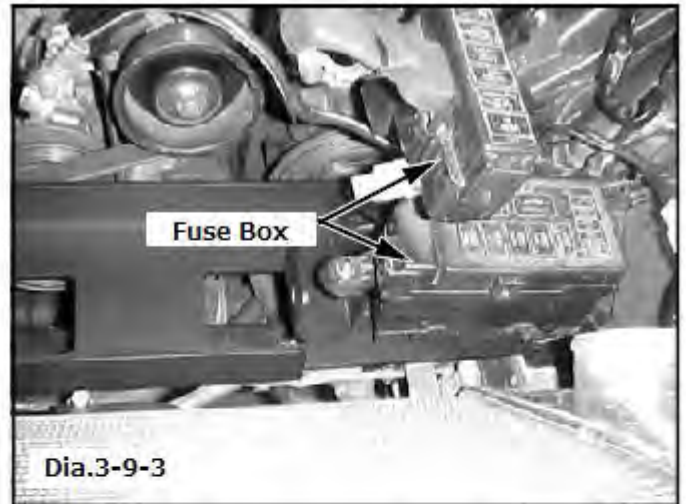

(7) Install the Air Separator Tank to the Battery Tray.
(Dia.3-9-4)

- Air Separator Tank Bracket x 1 (P17)
- Bolt M6 L=15 x 1 (P42)
- Flange Nut M6 x 1 (P51)
- Flat Washer M6 x 1 (P52)
- Spring Washer M6 x 1 (P55)
- Factory Bolt

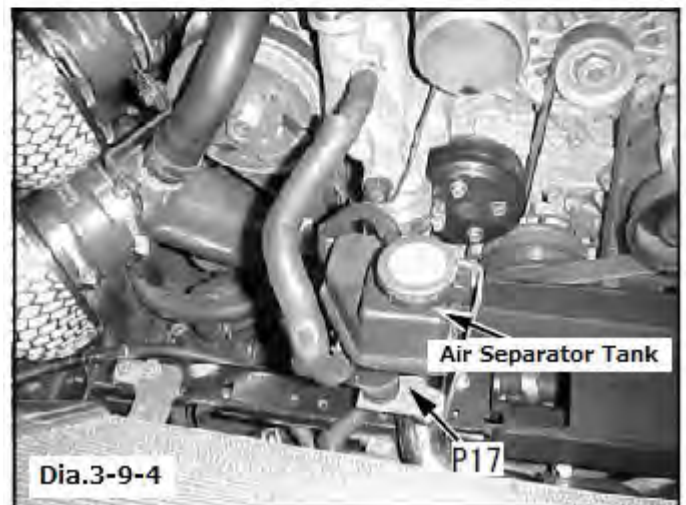

(8) Install the battery using the following provided parts.
(Dia.3-9-5)

- Battery Bracket x 1 (P19)
- Factory Rod
- Factory Nut

(9) Install the Battery Collar to the battery terminal.
Install the battery terminal.

- Battery Collar x 2 (P33)

(10) Install the red terminal cover of the positive side using the provided Tie Wrap (S).

(11) Secure the negative side's harness with the provided Tie Wrap (L) so the harness does not come in contact with the belt.

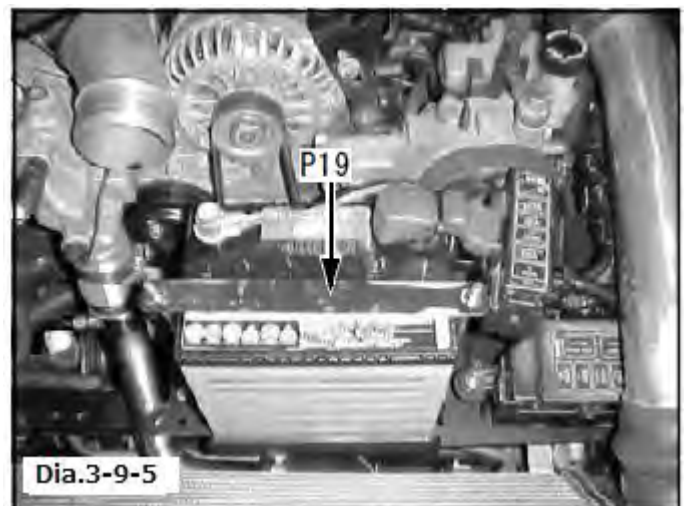

4. Re-installation of Factory Parts

※4-1 is the procedure required only for the vehicle manufactured after December,1998.

For a Vehicle Manufactured after December, 1998

4-1. Installation of Horn

- (1) Modify the horn on the passenger's side as shown in the diagram 4-1-1.
- (2) Bend the both horns and install them to the vehicle using the following provided parts. (Dia.4-1-1)
 - Flange Nut M6 x 1 (P51)
 - Factory Bolt

NOTE

- After modification of the bumper face, temporarily install the bumper face; then, adjust the position and angle of the horns.
- Make sure the horn on the driver's side does not come in contact with the release wire.

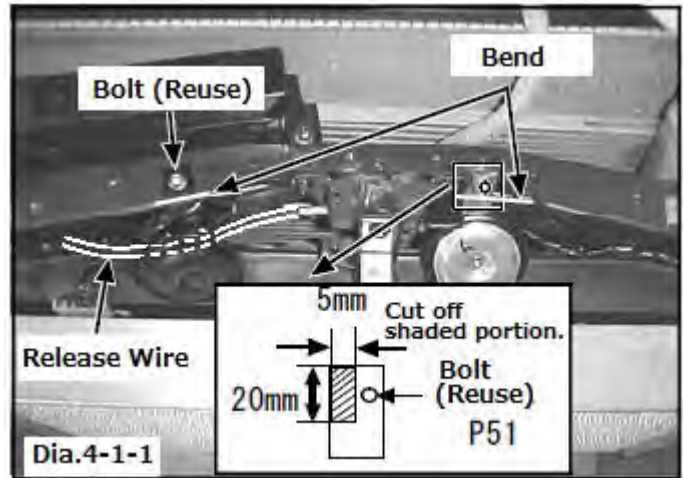

4-2. Installation of Bumper Face

- (1) Cut off the portion where the radiator comes in contact with the bumper.
- (2) Install the bumper face to the vehicle.

4-3. Installation of Fuse Relay Box

- (1) Install the fuse relay box using the provide Tie Wrap (L).

4-4. Refill Power Steering Fluid, Coolant, and A/C Gas

- (1) Refill the power steering fluid, coolant, and A/C gas.

CAUTION

- Make sure to completely bleed air from coolant water. If neglected, it may cause overheat resulting in engine damage..

5. Confirmation after Installation

- (1) After the installation process is complete, check all items listed in the "Confirmation After Installation" section of the Instruction Manual.